

# Baseball Cap

## EXTERIOR

PANEL: COLOR /SWATCH: FABRIC:

**IMPORTANT NOTE:** Please use heathered navy fabric swatch 777/1-7 selected from Ace swatch book

A	777/1-7	heathered 80% Acrylic / 20% Wool
B	777/1-7	heathered 80% Acrylic / 20% Wool
C	Black	Poly mesh
D	Black	Poly mesh
E	Black	Poly mesh
F	Black	Poly Mesh

**IMPORTANT NOTE:** Please use high quality soft handfeel poly mesh

VISOR:

G	Black	heathered 85% Acrylic / 15% Wool
---	-------	----------------------------------

## INTERIOR

**IMPORTANT NOTE:** USE SAME PRINTED FABRIC FOR: UNDERVISOR & LINING

PANEL:	COLOR:	FABRIC:
H	- PRINT	Performance fabric
I	- PRINT	Performance fabric
J	- N/A	
K	- N/A	
L	- N/A	
M	- N/A	

UNDERVISOR:

N	PRINT	Performance fabric
---	-------	--------------------

## DETAILS

DETAIL:	COLOR:	FABRIC:
Sweatband	Match to 777/1-7	non-woven buckram
Top Button	Black	85% Acrylic / 15% Wool
Sandwich	Pantone C	-
Flip Visor	Pantone C	-

## PIPING

PANELS:	COLOR:	FABRIC:
A / F	Pantone C	- Acrylic 100%
B / C	Pantone C	-
C / D	Pantone C	-
E / F	Pantone C	-

## EYELTS

PANEL:	THREAD COLOR:
A	Black
B	Black
C	Black
D	Black
E	Black
F	Black



## EMBROIDERY

THREAD COLORS:	EMB. TYPE:
Black	(PUFFY EMB)



HEATHER GRAY & SOLID BLACK SKETCH

## LEFT PANEL

### EMBROIDERY

PLACEMENT:  
-.37" IN 9.39 MM  
away from seam  
-.25" IN 6.35 MM  
away bottom edge

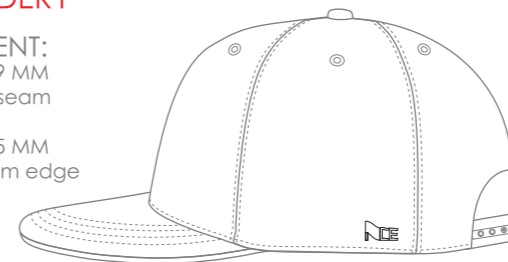

THREAD COLORS:  
 Pantone BLACK 3C

EMB. TYPE: DIRECT EMB



(ART AT ACTUAL SIZE)

## BACK PANEL E (EMB & FLAG LABEL)

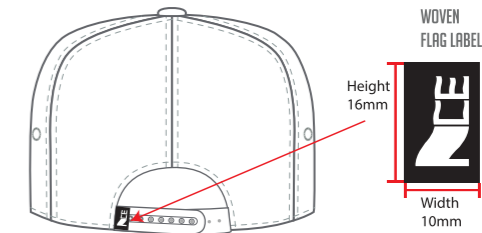

FLAG LABEL COLORS:  
 Pantone BLACK 3C  
 White  
PLACEMENT  
-Center on wearers left STRAP

## TAPING

TAPING COLOR:

BLACK

SCREEN PRINT:

WHITE



(ART AT ACTUAL SIZE)

DISTANCE 0.23in 5.84mm

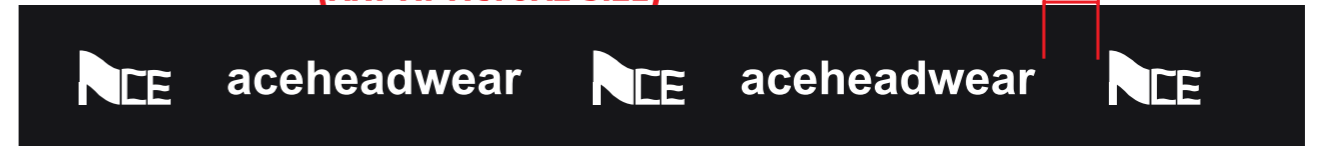

## DYE SUB PATCH (ACTUAL SIZE)

2MM EMB THICKNESS



FINISHED



### DYE SUB COLORS

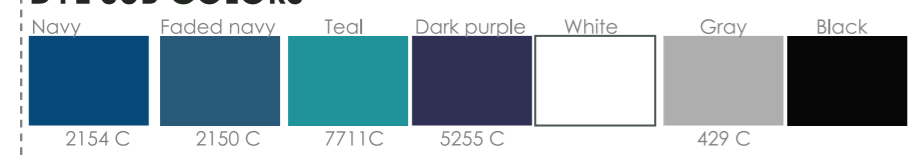

## PANEL A & B

PLACEMENT:

CENTER OF PANELS A & B

PLACE 0.5" IN ABOVE BOTTOM SEAM.  
-Dye sub patch with thick black emb

## STITCHING

PANEL: COLOR:

A	<input type="checkbox"/>	to match panel
B	<input type="checkbox"/>	to match panel
C	<input type="checkbox"/>	To match panel
D	<input type="checkbox"/>	To match panel
E	<input type="checkbox"/>	To match panel
F	<input type="checkbox"/>	To match panel

TOP VISOR:

G  To match

UNDER VISOR:

N  7711 C

SWEATBAND:

O  to match

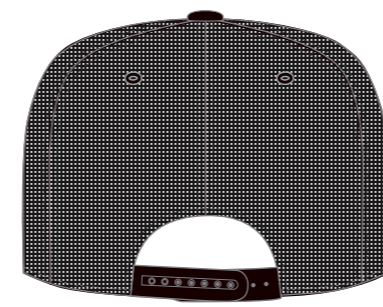

## STRAP

COLOR:  
 Black

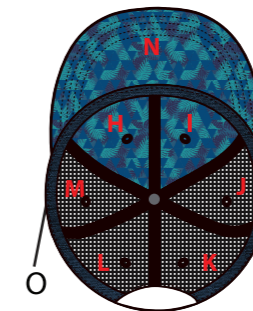

## LABEL

(ART AT ACTUAL SIZE)

INTERIOR LABEL

JINX non-woven buckram Label:

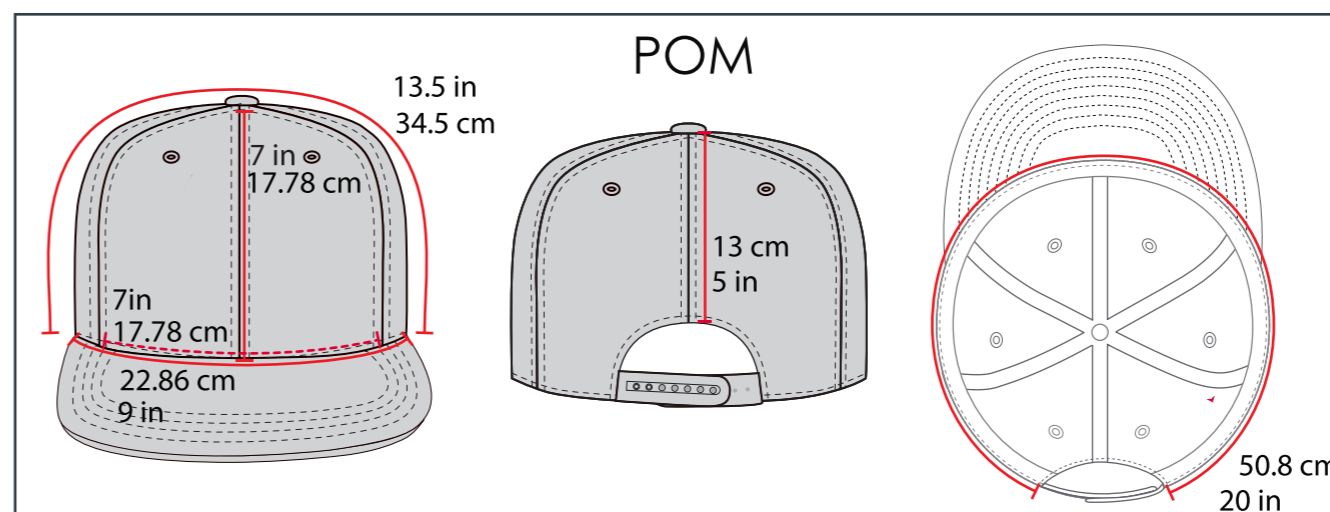
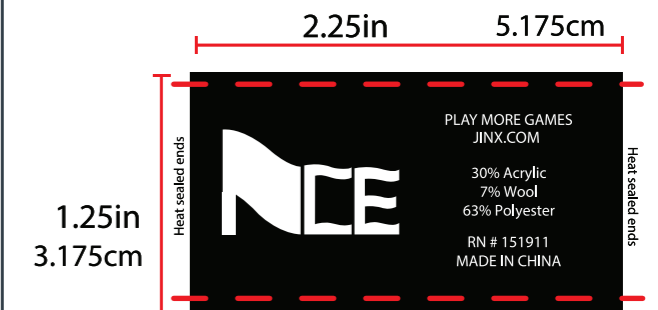

# Trucker Hat

## EXTERIOR

PANEL: COLOR /SWATCH: FABRIC:

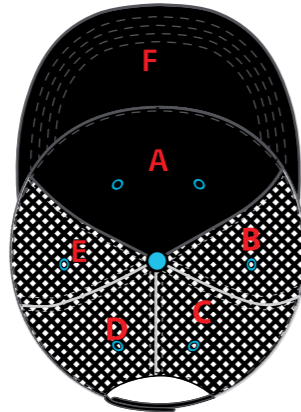

- A  CODE #33 Or Rich black 100% COTTON TWILL
- B  TCX 19-4003 or Rich black 100% POLYESTER MESH
- C  TCX 19-4003 or Rich black 100% POLYESTER MESH
- D  TCX 19-4003 or Rich black 100% POLYESTER MESH
- E  TCX 19-4003 or Rich black 100% POLYESTER MESH

CODES TAKEN FROM #JH 16\*10 - 100% COTTON ACE CODE BOOKS



## DETAILS

DETAIL: COLOR:

- Sweatband  TCX 19-4003 or Rich black
- Top Button  CODE #42 100% COTTON TWILL
- Sandwich  Pantone C
- Flip Visor  Pantone C

CODES TAKEN FROM #JH 16\*12 - 100% COTTON ACE CODE BOOKS





## PIPING

PANELS: COLOR: FABRIC:

- A / F  Pantone C -
- B / C  Pantone C -
- C / D  Pantone C -
- E / F  Pantone C -

## EYLETS

PANEL: THREAD COLOR:

- A  TEAL PMS 2985 C
- B  TEAL PMS 2985 C
- C  TEAL PMS 2985 C
- D  TEAL PMS 2985 C
- E  TEAL PMS 2985 C

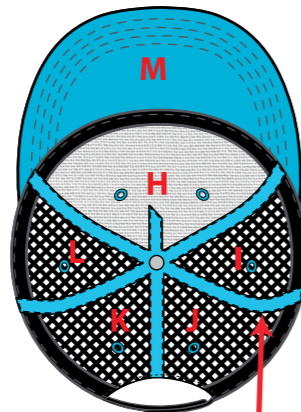

INTERIOR SOLID CONTRAST TAPING

-  TEAL PMS 2985 C

VISOR:

- F  CODE #33 100% COTTON TWILL

CODES TAKEN FROM #JH 16\*10 - 100% COTTON ACE CODE BOOKS

## INTERIOR

PANEL: COLOR: FABRIC:

- H  N/A
- I  N/A
- J  N/A
- K  N/A
- L  N/A

NOTE: NO LINER INCLUDED BUCKRAM VISIBLE

UNDERVISOR:

- M  CODE #42 100% COTTON TWILL

CODES TAKEN FROM #JH 16\*12 - 100% COTTON ACE CODE BOOKS

## SKETCH

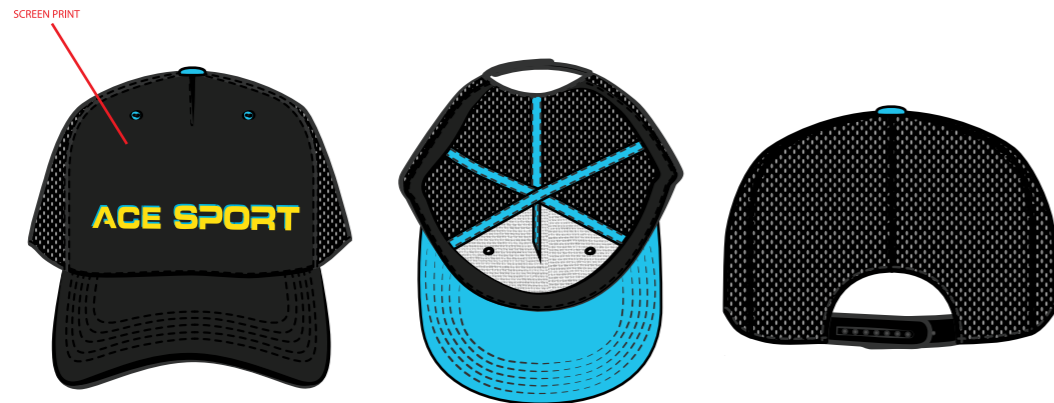

## SCREEN PRINT COLORS:



YELLOW  
PMS 803 C







TEAL  
PMS 2985

W: 3.30" in  
8.3 cm



## STITCHING

PANEL: COLOR:

- A  to match panel
- B  to match panel
- C  To match panel
- D  To match panel
- E  To match panel

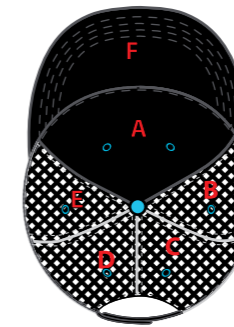

TOP VISOR:

- F  To match panel

UNDER VISOR:

- M  To match panel

SWEATBAND:

- O  to match

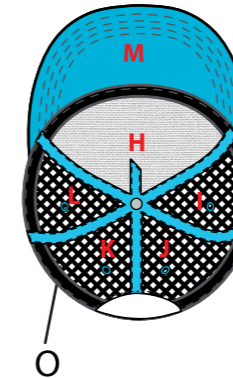

## STRAP COLOR:

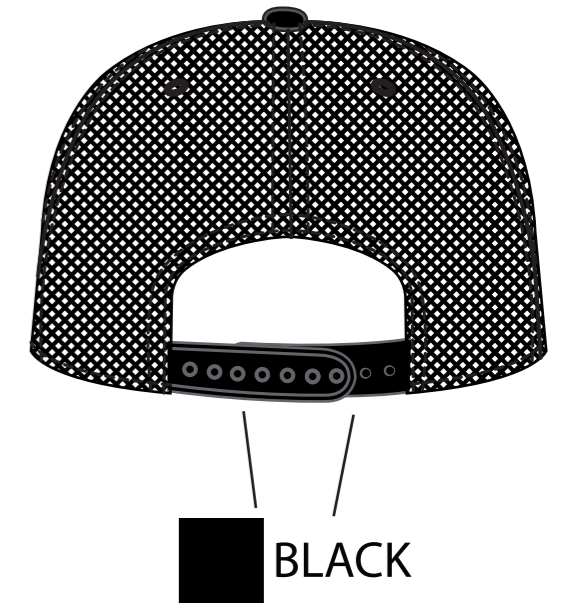

## LABEL

(ART AT ACTUAL SIZE)

INTERIOR LABEL

JINX non-woven buckram Label: 81% / 19%

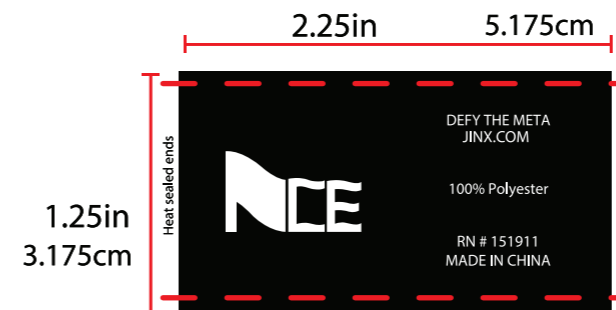

# Bucket Hat

## EXTERIOR

PANEL: COLOR /SWATCH: FABRIC:

**IMPORTANT NOTE:** Please use heathered navy fabric swatch 777/1-7 selected from Ace swatch book

A		777/1-7	heathered 80% Acrylic / 20% Wool
B		777/1-7	heathered 80% Acrylic / 20% Wool
C		Black	Poly mesh
D		Black	Poly mesh

**IMPORTANT NOTE:**  
Please use high quality soft handfeel poly mesh

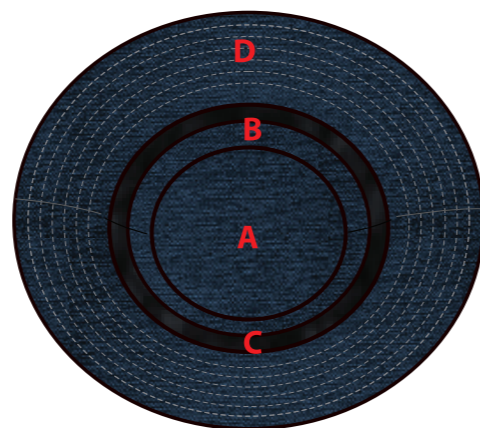

## INTERIOR

**IMPORTANT NOTE:**  
USE SAME PRINTED FABRIC FOR :  
UNDERSIVOR & LINING

PANEL:	COLOR:	FABRIC:
H		- PRINT Performance fabric
I		- PRINT Performance fabric
J		- N/A
K		- N/A
L		- N/A

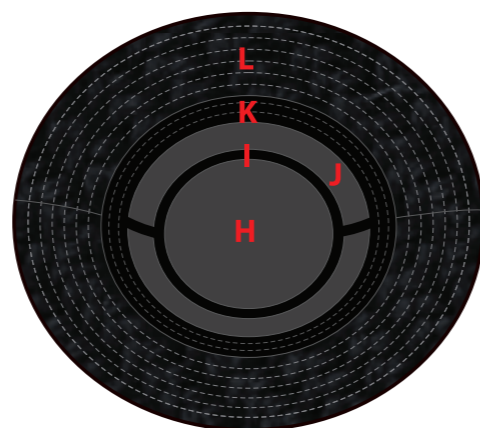

## DETAILS

DETAIL:	COLOR:	FABRIC:
Sweatband		Match to 777/1-7 non-woven buckram
Top Button		Black 85% Acrylic / 15% Wool
Sandwich		Pantone C -
Flip Visor		Pantone C -

## PIPING

PANELS:	COLOR:	FABRIC:
A / F		Pantone C - Acrylic 100%
B / C		Pantone C -
C / D		Pantone C -
E / F		Pantone C -

## EYLETTS

PANEL:	THREAD COLOR:	
A		Black
B		Black
C		Black
D		Black
E		Black
F		Black

## POM

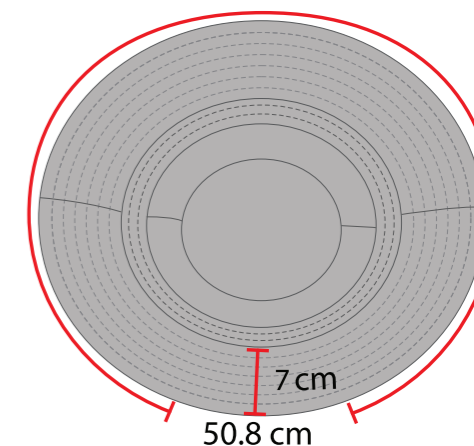
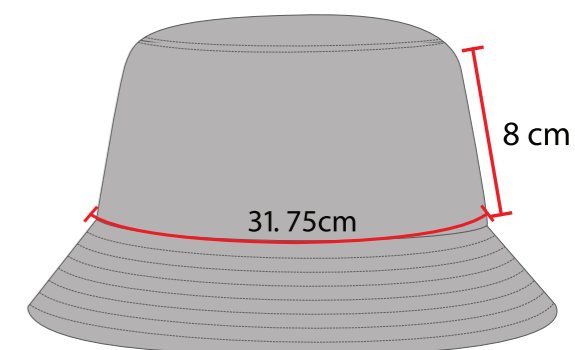

## LABEL

**(ART AT ACTUAL SIZE)**

INTERIOR LABEL

JINX non-woven buckram Label:

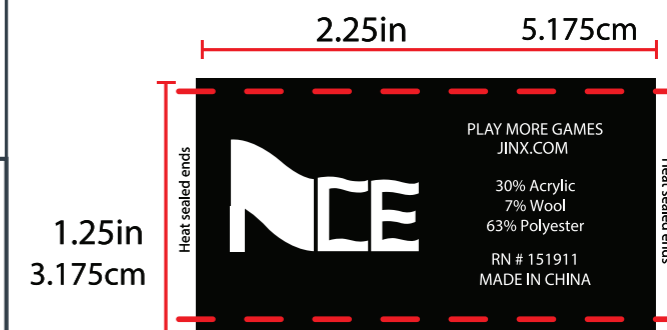

## DYE SUB PATCH (ACTUAL SIZE)

PLACE 0.5" IN ABOVE BOTTOM SEAM.  
-Dye sub patch with thick black emb



**ACE** 8/3" IN DIAMETER PATCH

### DYE SUB COLORS



## PANEL

PLACEMENT: C

CENTER OF PANELS C

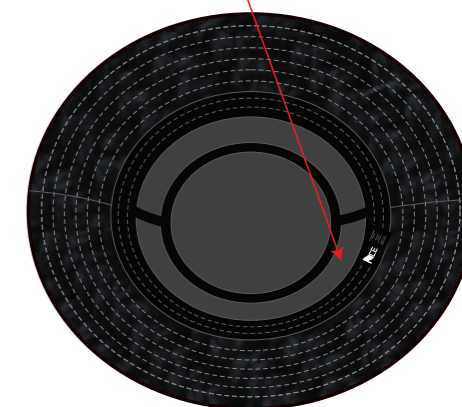

**(ART AT ACTUAL SIZE)**

DISTANCE 0.23in 5.84mm

## TAPING

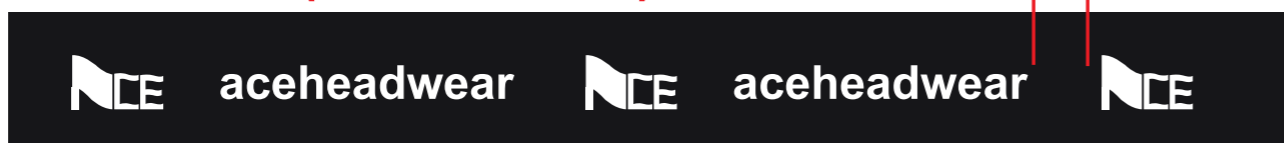

TAPING COLOR:

BLACK

SCREEN PRINT:

WHITE



# Snapback Cap

## EXTERIOR

PANEL: COLOR /SWATCH: FABRIC:

- A  Light gray swatch #16 100% Polyester ripstop
- B  Light gray swatch #16 100% Polyester ripstop
- C  Burgundy swatch #10 100% Polyester ripstop / Laser cut
- D  Burgundy swatch #10 100% Polyester ripstop /Laser cut
- E  Burgundy swatch #10 100% Polyester ripstop /Laser cut
- F  Burgundy swatch #10 100% Polyester ripstop / Laser cut

PLEASE NOTE  
COLORS CODES  
ARE FROM ACE  
FABRIC SWATCH CARD

## DETAILS

- DETAIL: COLOR: FABRIC:
- Sweatband  Match color to Burgundy swatch #10 non-woven buckram
  - Top Button  Black swatch #11 100% Polyester ripstop
  - Sandwich  Pantone C - Intense black
  - Flip Visor  Pantone C -

## BINDING

- PANELS: COLOR: FABRIC:
- P  Burgundy swatch #10 100% Polyester ripstop

## VISOR:

- G  Black swatch #11 100% Polyester ripstop

## INTERIOR

NOTE: LINING WILL TAKE A CUSTOM PRINT

PANEL: COLOR: FABRIC:

- H  - NONE
- I  -
- J  -
- K  -
- L  -
- M  -

## UNDERSVISOR:

- N  Black swatch #11 100% Polyester ripstop

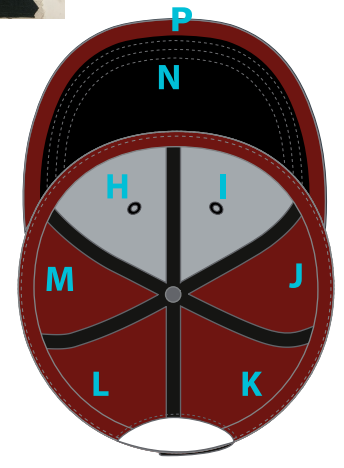

## EYELETS

PANEL: THREAD COLOR:

- A  Match color black swatch #11
- B  Match color black swatch #11
- C  N/A
- D  N/A
- E  N/A
- F  N/A

## EMBROIDERY ON BACK PANEL E (EMB & FLAG LABEL)

BACK SIDE OF FLAG LABEL

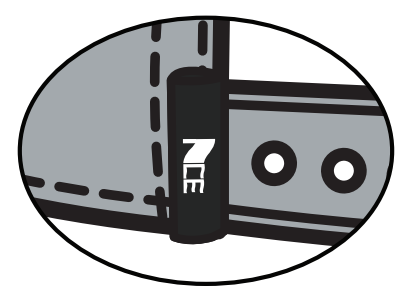
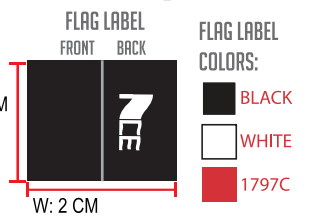
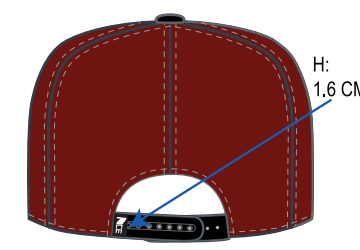

-PLACEMENT  
-Center on wearers left STRAP

## POM

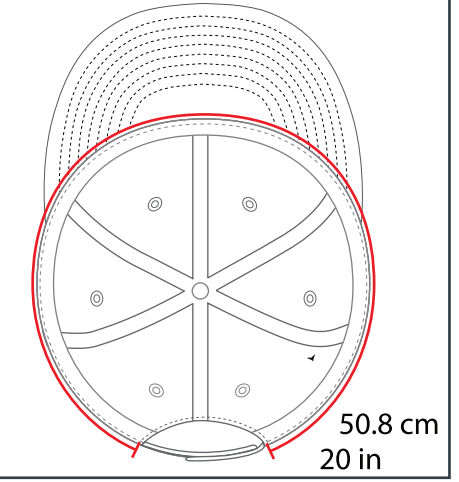
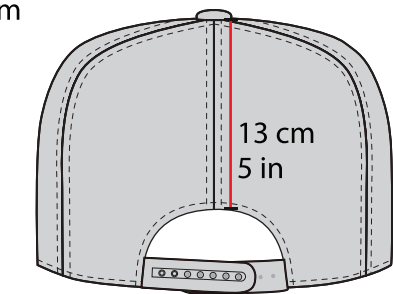
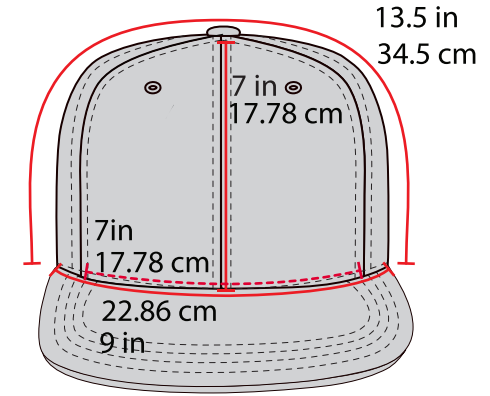

## DYE SUB EMB. EDGE PATCH

DYE SUB



H: 2.75" in  
6.98 cm

W: 2.80" in  
7.11 cm

FINISHED



W: 2.80" in  
7.11 cm

EMB

THICKNESS: 2MM PUFFY EMB  
COLOR CODE: 8634  
(SELECTED FROM ACE THREAD BOOK)

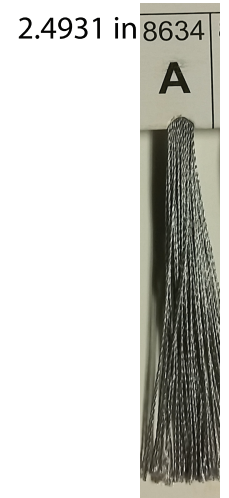

## PANEL A & B

PLACEMENT:

CENTER OF PANELS A & B  
PLACE 1" IN ABOVE BOTTOM SEAM.  
-Twill fabric applique with edge emb.  
-Base rubber patch thickness: 1MM

## DYE SUB COLORS

BLACK



WHITE



RED  
1797 C



GRAY  
429 C

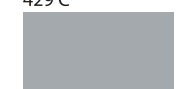

## LABEL

(ART AT ACTUAL SIZE)

INTERIOR LABEL

JINX non-woven buckram Label: 81% / 19%

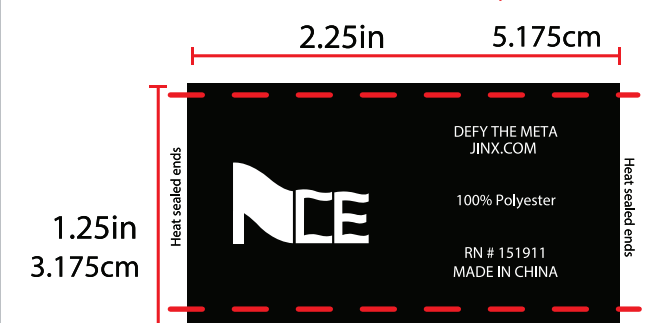

## TAPING

TAPING COLOR:

- BLACK
- WHITE

SCREEN PRINT:



(ART AT ACTUAL SIZE)

DISTANCE 0.23in 5.84mm

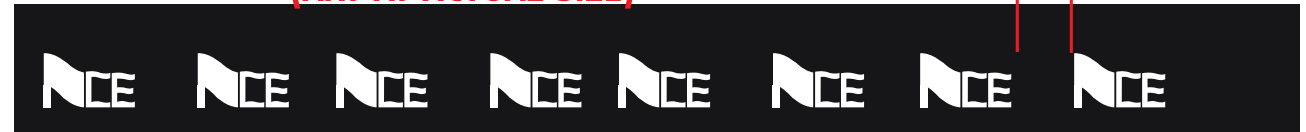

# Camping Cap

## EXTERIOR

PANEL: COLOR /SWATCH: FABRIC:

A	Light gray swatch #16	100% Polyester ripstop	
B	Light gray swatch #16	100% Polyester ripstop	
C	Burgundy swatch #10	100% Polyester ripstop / Laser cut	
D	Burgundy swatch #10	100% Polyester ripstop /Laser cut	
E	Burgundy swatch #10	100% Polyester ripstop /Laser cut	
F	Burgundy swatch #10	100% Polyester ripstop / Laser cut	

PLEASE NOTE  
COLORS CODES  
ARE FROM ACE  
FABRIC SWATCH CARD

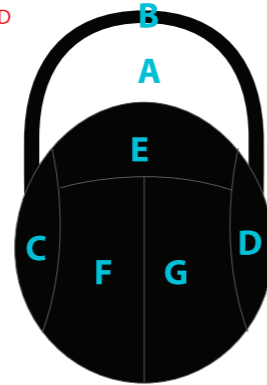

VISOR:

G	Black swatch #11	100% Polyester ripstop	
---	------------------	------------------------	--

## INTERIOR

NOTE: LINING WILL  
TAKE A CUSTOM PRINT

PANEL: COLOR: FABRIC:

H	-	NONE
I	-	
J	-	
K	-	
L	-	
M	-	

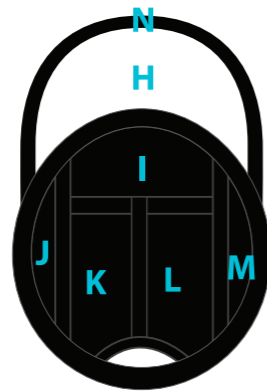

UNDERSVISOR:

N	Black swatch #11	100% Polyester ripstop
---	------------------	------------------------

## DETAILS

DETAIL:	COLOR:	FABRIC:
Sweatband	Match color to Burgundy swatch #10	non-woven buckram

## EYLETS

PANEL: THREAD COLOR:

A	Match color black swatch #11
B	Match color black swatch #11
C	N/A
D	N/A
E	N/A
F	N/A

## EMBROIDERY ON BACK PANEL E (EMB & FLAG LABEL)

BACK SIDE OF  
FLAG LABEL

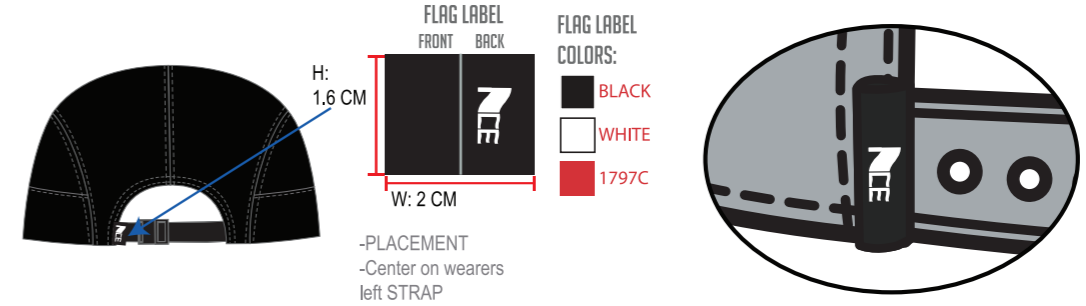

-PLACEMENT  
-Center on wearers  
left STRAP

## POM

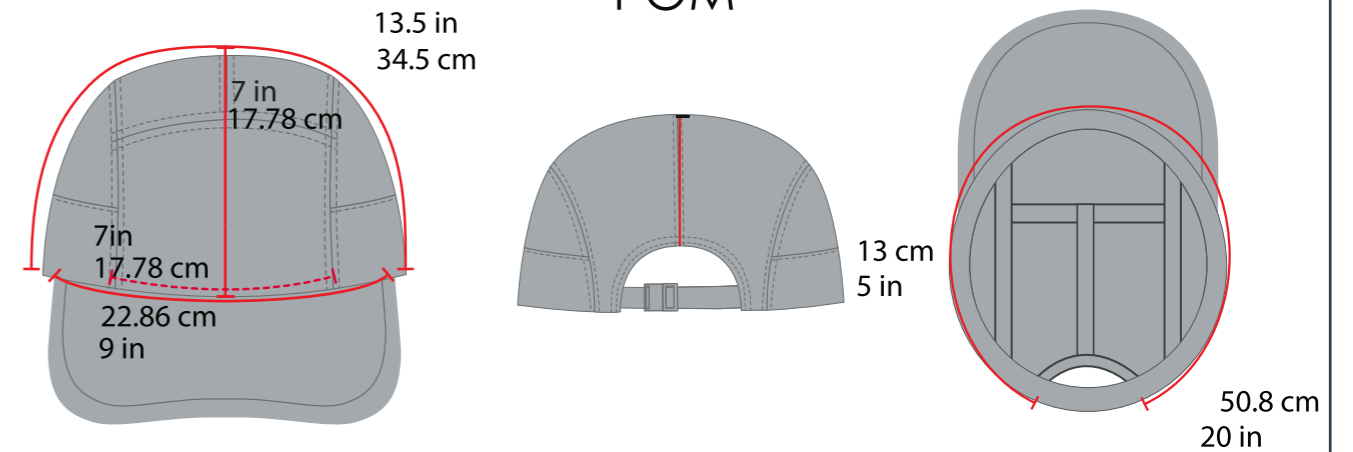

## LABEL

(ART AT ACTUAL SIZE)

INTERIOR LABEL

JINX non-woven buckram Label: 81% / 19%

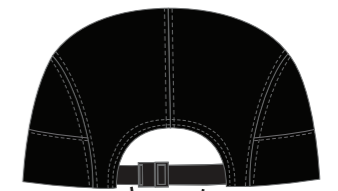
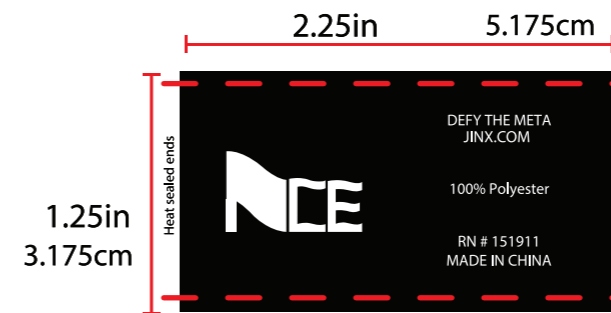

STRAP

COLOR:

Match color black swatch #11
------------------------------

## DYE SUB EMB. EDGE PATCH

DYE SUB



H: 2.75" in  
6.98 cm

W: 2.80" in  
7.11 cm

EMB

THICKNESS: 2MM PUFFY EMB  
COLOR CODE: 8634  
(SELECTED FROM ACE THREAD BOOK)

DYE SUB COLORS

WHITE



## TAPING

TAPING COLOR:

BLACK	WHITE
-------	-------

SCREEN PRINT:



(ART AT ACTUAL SIZE)

DISTANCE 0.23in 5.84mm



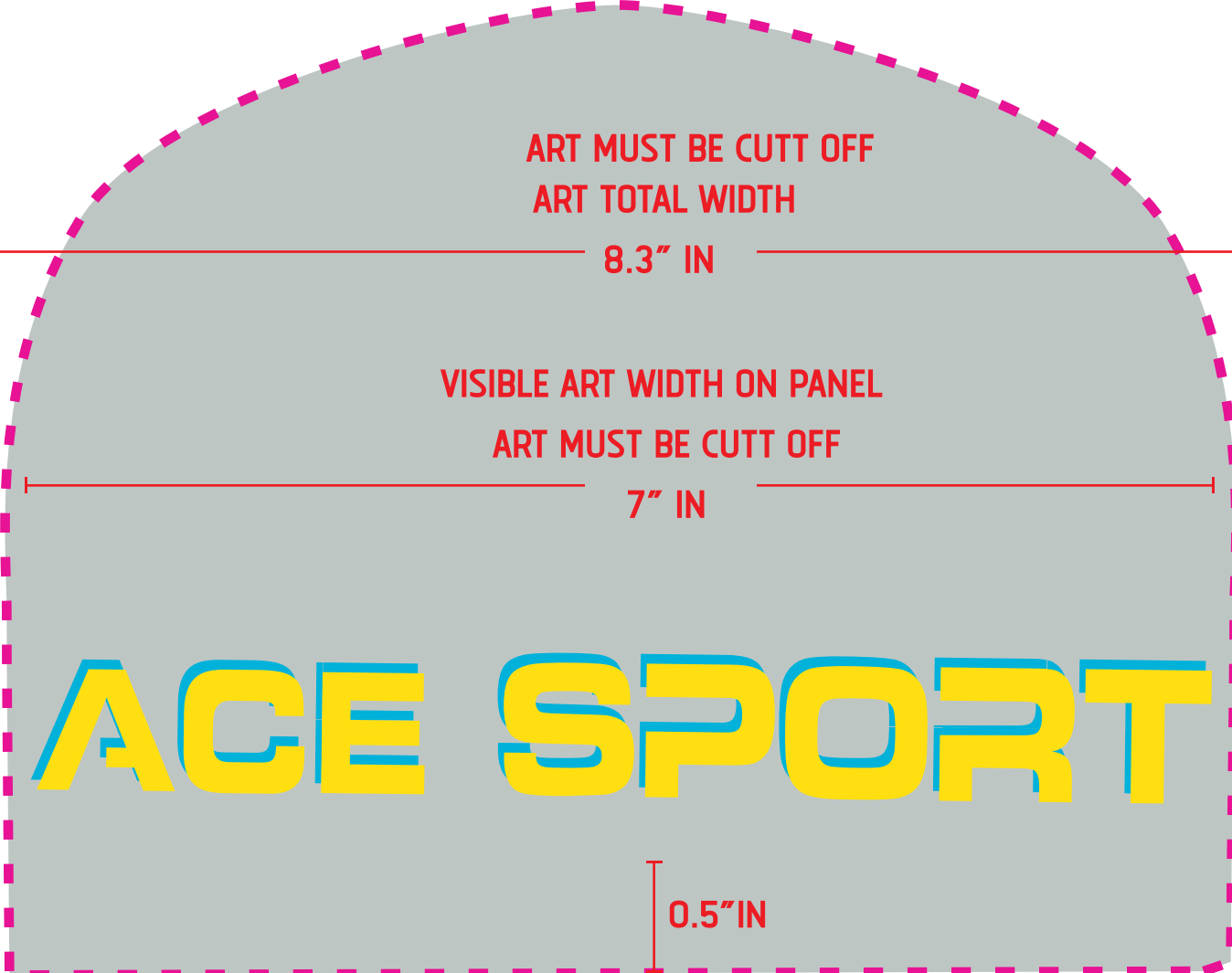

DASHED LINE INDICATES  
PANEL PIECE  
- INDICATING WERE  
ARTWORK CUTS OFF ON PANEL

GRAY FILL INDICATES  
CENTER FRONT PANEL

PLACEMENT:  
Please ensure  
screen print must be placed 0.5" inches from  
bottom of CF panel

SCREEN PRINT COLORS:

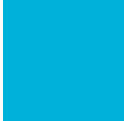
	
YELLOW PMS 803 C	TEAL PMS 2985