

Bucket Hat

EXTERIOR

PANEL: COLOR /SWATCH: FABRIC:

IMPORTANT NOTE: Please use heathered navy fabric swatch 777/1-7 selected from Ace swatch book

A		777/1-7	heathered 80% Acrylic / 20% Wool
B		777/1-7	heathered 80% Acrylic / 20% Wool
C		Black	Poly mesh
D		Black	Poly mesh

IMPORTANT NOTE:
Please use high quality soft handfeel poly mesh

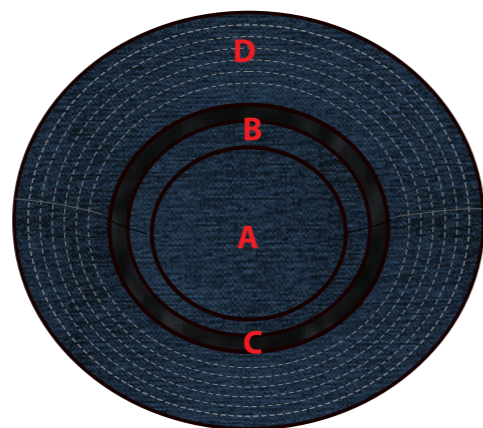

INTERIOR

IMPORTANT NOTE:
USE SAME PRINTED FABRIC FOR :
UNDERSIVOR & LINING

PANEL:	COLOR:	FABRIC:
H		- PRINT Performance fabric
I		- PRINT Performance fabric
J		- N/A
K		- N/A
L		- N/A

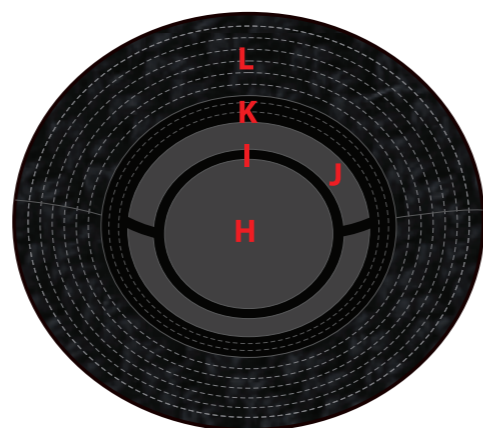

DETAILS

DETAIL:	COLOR:	FABRIC:
Sweatband		Match to 777/1-7 non-woven buckram
Top Button		Black 85% Acrylic / 15% Wool
Sandwich		Pantone C -
Flip Visor		Pantone C -

PIPING

PANELS:	COLOR:	FABRIC:
A / F		Pantone C - Acrylic 100%
B / C		Pantone C -
C / D		Pantone C -
E / F		Pantone C -

EYLETTS

PANEL:	THREAD COLOR:	
A		Black
B		Black
C		Black
D		Black
E		Black
F		Black

POM

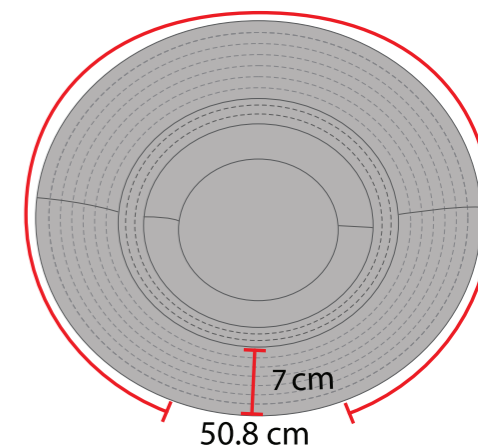
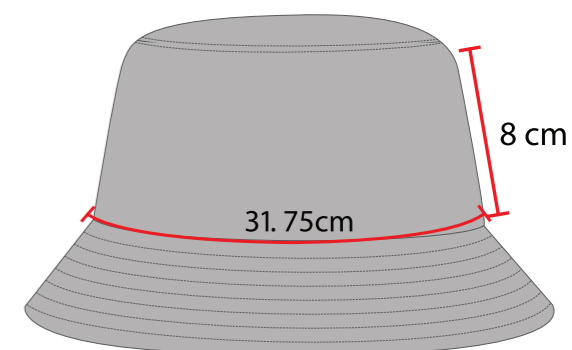

LABEL

(ART AT ACTUAL SIZE)

INTERIOR LABEL

JINX non-woven buckram Label:

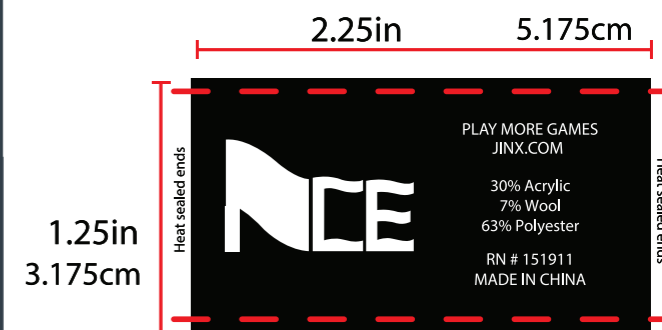

DYE SUB PATCH (ACTUAL SIZE)

PLACE 0.5" IN ABOVE BOTTOM SEAM.
-Dye sub patch with thick black emb



ACE 8/3" IN DIAMETER PATCH

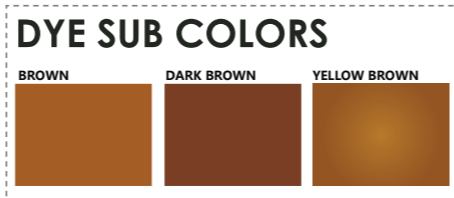

PANEL

PLACEMENT: C

CENTER OF PANELS C

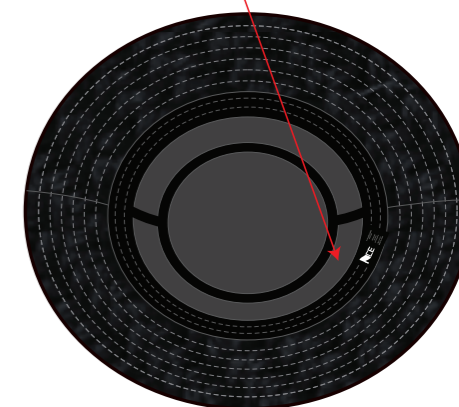

(ART AT ACTUAL SIZE)

DISTANCE 0.23in 5.84mm

TAPING

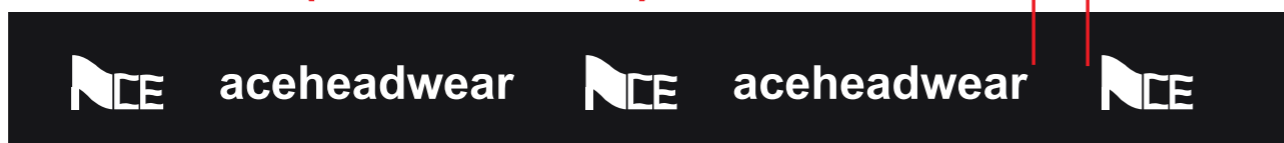

TAPING COLOR:



SCREEN PRINT:

