

Baseball Cap

EXTERIOR

PANEL: COLOR /SWATCH: FABRIC:

IMPORTANT NOTE: Please use heathered navy fabric swatch 777/1-7 selected from Ace swatch book

A	777/1-7	heathered 80% Acrylic / 20% Wool
B	777/1-7	heathered 80% Acrylic / 20% Wool
C	Black	Poly mesh
D	Black	Poly mesh
E	Black	Poly mesh
F	Black	Poly Mesh

IMPORTANT NOTE: Please use high quality soft handfeel poly mesh

VISOR:

G	Black	heathered 85% Acrylic / 15% Wool
---	-------	----------------------------------

INTERIOR

IMPORTANT NOTE: USE SAME PRINTED FABRIC FOR: UNDERVISOR & LINING

PANEL: COLOR: FABRIC:

H	-	PRINT	Performance fabric
I	-	PRINT	Performance fabric
J	-	N/A	
K	-	N/A	
L	-	N/A	
M	-	N/A	

UNDERVISOR:

N	PRINT	Performance fabric
---	-------	--------------------

DETAILS

DETAIL: COLOR: FABRIC:

Sweatband	Match to 777/1-7	non-woven buckram
Top Button	Black	85% Acrylic / 15% Wool
Sandwich	Pantone C	-
Flip Visor	Pantone C	-

PIPING

PANELS: COLOR: FABRIC:

A / F	Pantone C	- Acrylic 100%
B / C	Pantone C	-
C / D	Pantone C	-
E / F	Pantone C	-

EYELETS

PANEL: THREAD COLOR:

A	Black
B	Black
C	Black
D	Black
E	Black
F	Black



EMBROIDERY

THREAD EMB. TYPE:
COLORS: (PUFFY EMB)

Black



HEATHER GRAY & SOLID BLACK SKETCH

LEFT PANEL

EMBROIDERY

PLACEMENT:
-.37" IN 9.39 MM
away from seam

-.25" IN 6.35 MM
away bottom edge

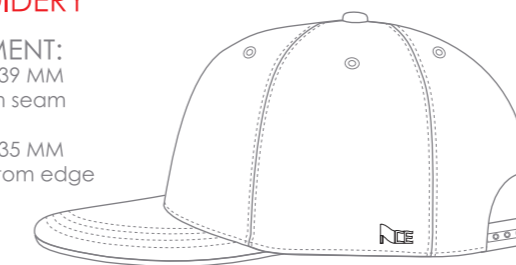

THREAD COLORS:

Pantone BLACK 3C

EMB. TYPE: DIRECT EMB



(ART AT ACTUAL SIZE)

BACK PANEL E (EMB & FLAG LABEL)

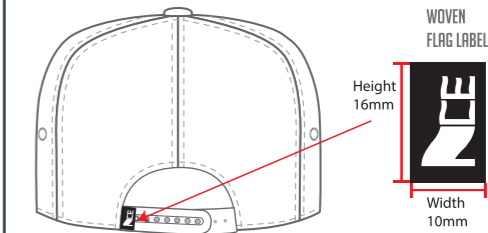

FLAG LABEL COLORS:

Black Pantone BLACK 3C

White

PLACEMENT

-Center on wearers left STRAP

TAPING

TAPING COLOR:

BLACK

SCREEN PRINT:

WHITE



(ART AT ACTUAL SIZE)

DISTANCE 0.23in 5.84mm

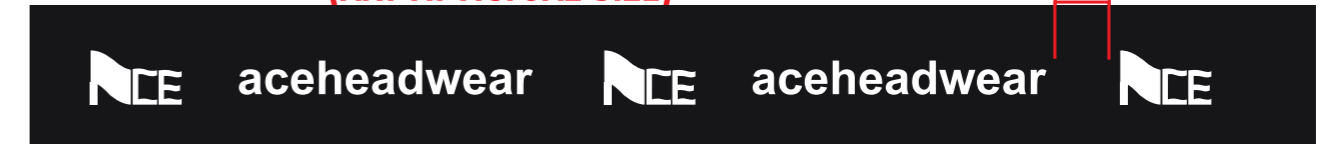

DYE SUB PATCH (ACTUAL SIZE)

2MM EMB THICKNESS



3" IN
DIAMETER
PATCH

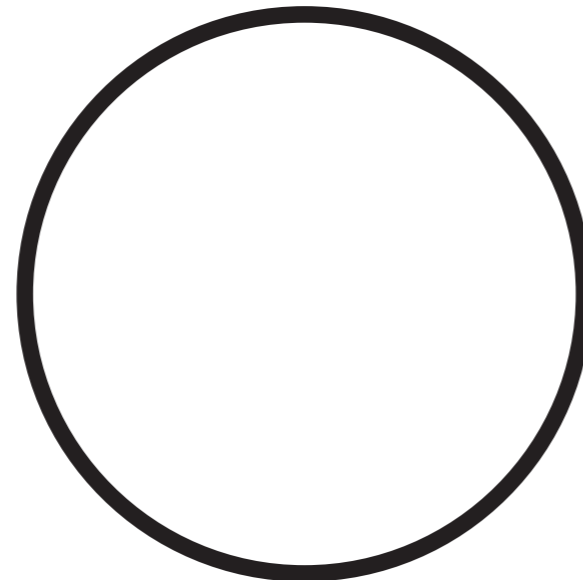

FINISHED



3" IN
DIAMETER
PATCH

DYE SUB COLORS

Navy	Faded navy	Teal	Dark purple	White	Gray	Black
2154 C	2150 C	7711 C	5255 C		429 C	

PANEL A & B

PLACEMENT:

CENTER OF PANELS A & B

PLACE 0.5" IN ABOVE BOTTOM SEAM.
-Dye sub patch with thick black emb

STITCHING

PANEL: COLOR:

A	to match panel
B	to match panel
C	To match panel
D	To match panel
E	To match panel
F	To match panel

TOP VISOR:

G	To match
---	----------

UNDER VISOR:

N	7711 C
---	--------

SWEATBAND:

O	to match
---	----------

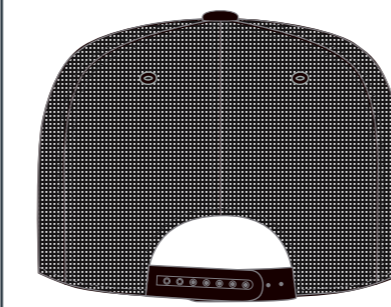

STRAP

COLOR:
Black

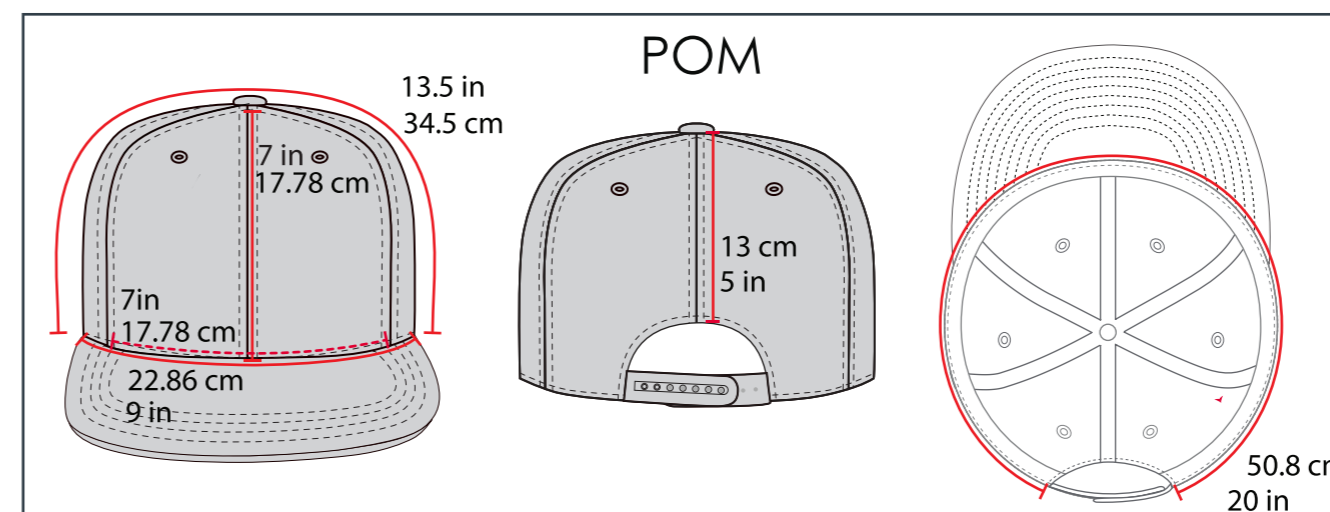
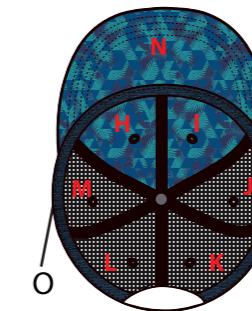

LABEL

(ART AT ACTUAL SIZE)

INTERIOR LABEL

JINX non-woven buckram Label:

